

**E1** 81R00/02\*0007\*02

<b>Issued by:</b>	Kraftfahrt-Bundesamt Fördestraße 16 24944 Flensburg Germany
<b>Place &amp; Date of type-approval:</b>	Flensburg, 17.01.2018
<b>Report No.:</b>	17-00189-CP-BWG-01
<b>Issued by:</b>	TÜV SÜD Auto Service GmbH Westendstraße 199 D-80686 München
<b>Date of issue:</b>	13.12.2017
<b>Approval identification:</b>	E1*81R00/02*0007*02

**Product Codes:** BS147B

**Technical Drawing:**

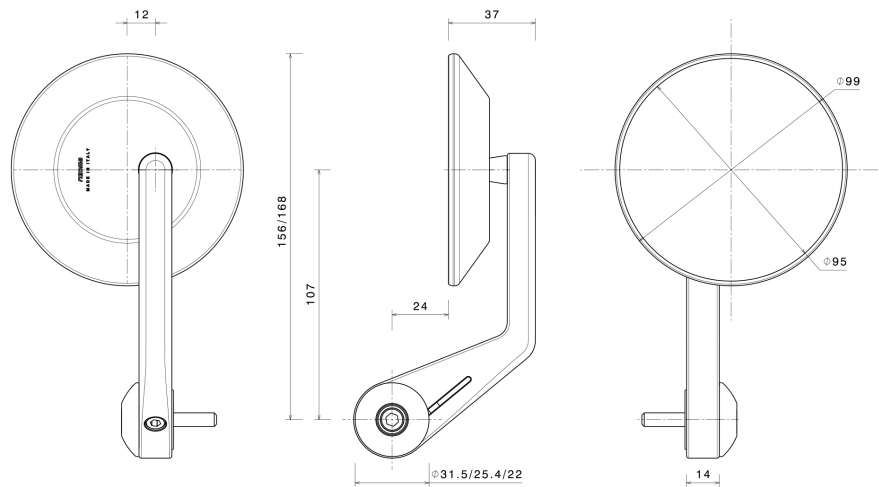

<b>Marking:</b>	Engraved by laser.
<b>Field of application:</b>	2 or 3 wheel motorcycles and vehicles treated as such. (PTWs, ATVs, Scooters, Motorcycles, Moped)